

Benvenuti!



innovaphone



- Costruttore tedesco di soluzioni professionali IP
- Fondata nel 1997 a Sindelfingen – filiale a Verona
- Pioniere Europeo della telefonia „pura“ – IP
- Produzione in Europa - Sviluppo e competenze strategiche all'interno dell'azienda
- Garanzia di una telefonia che si adatta ai vostri processi aziendali e non viceversa
- OGGI e in FUTURO -
- Concetto di prodotto unico che permette inaspettate libertà: dalla migrazione ai servizi
- Integrazione delle nuove tecnologie e applicazioni, come UCC e Mobility

innovaphone



..... Pure IP-Telephony



- **innovaphone PBX**
- **Gateway VoIP**
- **Telefoni IP**
- **Soluzioni IP-DECT**
- **Telefoni WLAN**
- **Adattatori IP**
- **Software VoIP:**
 - CTI**
 - Voice-Mail**
 - UMS**
 - Billing**

innovaphone



innovaphone a confronto

il PBX è integrato nel Gateway

Non richiede server



Green IT versus Green VOIP



Studio Gennaio 2009:

„innovaphone costruisce il centralino VoIP con la più alta efficienza energetica “

„IP6000-800-305 sono la nuova classe di referenza“

Un PBX per 2000 interni che consuma 10 Watt esiste veramente“

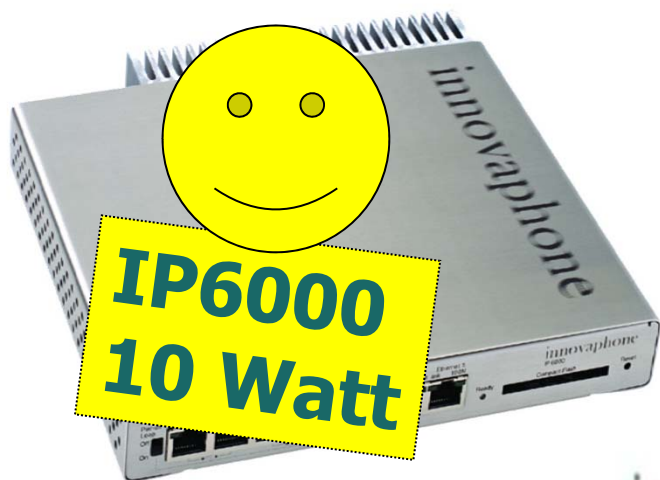

innovaphone



Calcolo ROI sui costi di energia

Soluzione con PC/server in confronto con soluzione innovaphone



prezzo kWh €

0,15

Situazione (senza UPS e condizionatori)

numero

watt

kW soluzione PC

kW innovaphone

server per centralino IP

1

550

0,55

0,0047

centralino di backup

1

550

0,55

0,0047

PC di gestione senza schermo

1

350

0,35

HTTP

schermo per console

1

120

0,12

HTTP

Voicemail (ulteriore PC)

1

550

0,55

Compact Flash

server di salvataggio

1

350

0,35

Compact Flash

server allarme

1

350

0,35

integrato

MOH (per sempio CD-Player)

1

60

0,06

Compact Flash

ventilatore per armadio 19"

1

20

0,02

non necessario

totale

2,9

0,0094

kWh al mese

2.158

7

costi mensili energia

324 €

1 €

costi annuali energia

3.811 €

12 €

costi energia in 5 anni

19.053 €

62 €

innovaphone ROI in 5 anni

18.991 €

emissioni CO2 annuali in kg

15.242

49

equivalente di produzione CO2 con automobile in km

9.527

31

innovaphone



Singoli gateway combinabili liberamente

Utenti:	senza limiti
Interfaccia:	senza limiti
Filiali:	senza limiti
PBX:	su qualsiasi modello
Standby PBX:	su qualsiasi modello
Gestione:	centrale
Incredibile:	si



VoIP Gateway/PBX

Scalabilità

Scalabilità: da 1 a infinti utenti
da 1 BRI a flussi primari o SIP Trunks

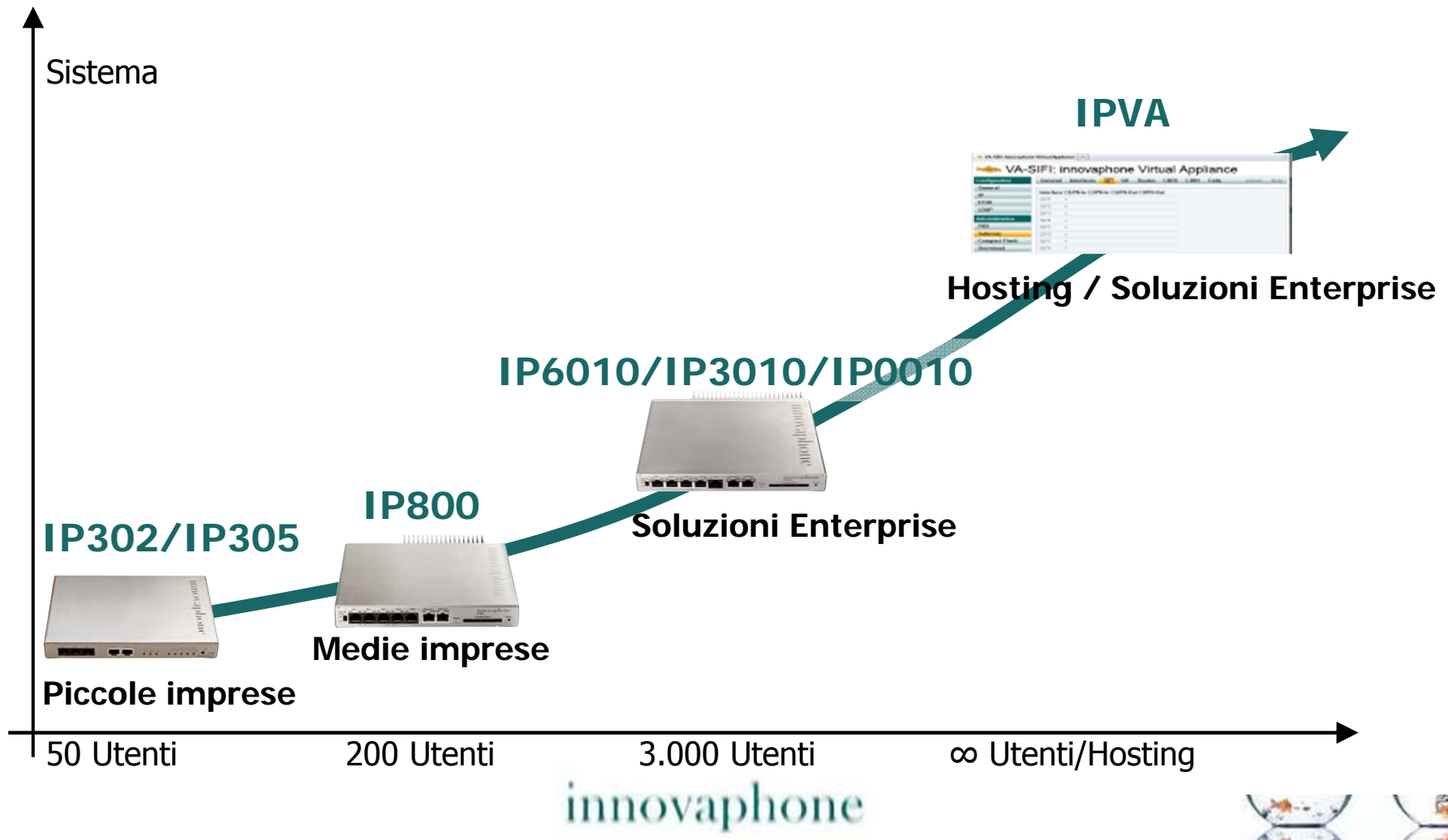

VoIP Gateways/Virtual Appliance

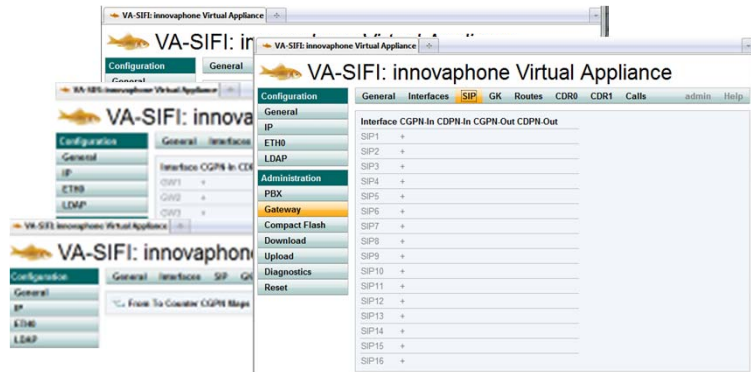

IP Virtual Appliance

- Virtual platform, gira direttamente su VM Ware
- Stesso firmware e software come sui gws



innovaphone Virtual Appliance without limitations, for hosting or huge scenarios

IP 1060



- Solo Media gateway
- 2 porte PRI e una porta BRI
- POE
- Conferenza finbo a 60 utenti

pure media gateway innovaphone IP1060

innovaphone



telefoni IP



La configurazione del telefono si può salvare e caricare anche dal PBX....



Vasta gamma con dna comune:

- doppia porta Ethernet
- power over LAN (802.3af)
- conferenza e voice recording
- ascolto amplificato, viva-voce e display
- multiprotocollo (H.323, SIP)
- protocollo PPTP (VPN) e servizi DHCP
- cifratura con chiave a bordo
- tasti configurabili e gestione cuffia
- rubrica interna e centrale in LDAP
- overlap sending
- direttore/segretario
- multiutente e PBX ridondante
-

innovaphone



il telefono del futuro

Il Problema: diversi gruppi di interesse

Tradizionalista

= io voglio il mio telefono



Modernista

= io amo finestre e mouse



Pragmatico

= mouse+telefono



innovaphone



il telefono del futuro ... così??

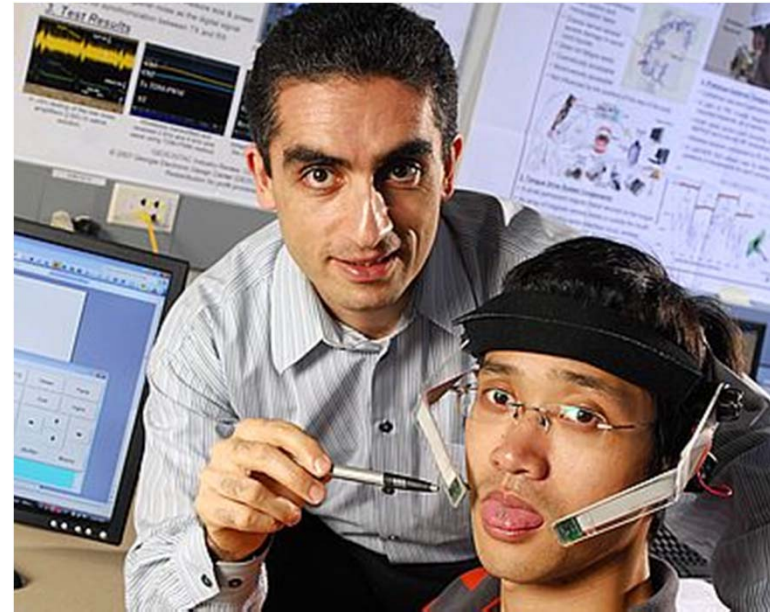

HAND PHONE

innovaphone



telefoni IP

..... la nuova generazione



innovaphone



telefoni IP

..... la nuova generazione



innovaphone



telefoni IP

..... la nuova generazione



innovaphone



telefoni IP

..... la nuova generazione

IP232



- Design moderno, sofisticato, con dettagli tecnici innovativi
- Grande display a colori con risoluzione ottimale IP222 3,5 Zoll, IP232 4,3 Zoll con Touchscreen
- Supporto dei protocolli H.323 e SIP
- Rubrica LDAP locale, aziendale e centrale
- 4 porte USB per cuffia, modulo aggiuntivo e altre periferiche
- Versione ottimizzata del codec G.722.2
- Nuovo Green IT Standard 802.3az
- Power over Ethernet secondo 802.3af – oppure alimentatore 220v
- Gigabit Switch

IP222



Modulo aggiuntivo



reddot design award
winner 2011

innovaphone



i display della nuova generazione

- Display a colori nitido e ad alta definizione
- Gestione menù intuitiva
- trasparente Menüpunkte
- Sfondo personalizzabile, per esempio con logo aziendale
- Medesima gestione menù della precedente generazione di telefoni, quindi utilizzo abituale



innovaphone



Applicativi



Piattaforma applicativi

Time	Duration	Destination
2010-11-10 09:28:05	0:25	005202939841 -> hns(40) -> Zentrals(400) ->
2010-11-10 09:49:20	0:00	005202939841 -> hns(40) -> Zentrals(400) ->
2010-11-10 09:23	0:00	005202939841 -> hns(40) -> Zentrals(400) ->
2010-11-10 11:18:18	0:00	005202939841 -> hns(40) -> Zentrals(400) ->
2010-11-10 12:03:01	0:00	005202939841 -> hns(40) -> Zentrals(400) ->
2010-11-10 12:03:05	0:00	005202939841 -> hns(40) -> Zentrals(400) ->

Reporting



Software Phone



Queue-Monitor



CTI

Name	Status
John Eckert	Status: Nicht bekannt
Lena Frisch	Status: Abwesend
Martin Seiler	Status: Nicht bekannt
Petra Hauser	Status: Abwesend
Robert Wagner	Status: Abwesend

CTI / SIP Federation



innovaphone Voicemail



Innovaphone PBX Operator



Piattaforma applicativi



- Disponibile con il nuovo Gateways xx10
- Processori separati e nessuna parte mobile garantiscono la massima disponibilità
- Tutte le funzioni UC senza server
- Piattaforma applicativa per Billing, Fax Server,...
- Debian Linux pronto (ARM EABI processor, Postgresql DB, Lighthttpd, WebDav, PHP5)
- Disponibile anche come VMWare Guest
- Amministrazione Linux attraverso innovaphone Web UI

innovaphone



Application piattaforma - Reporting

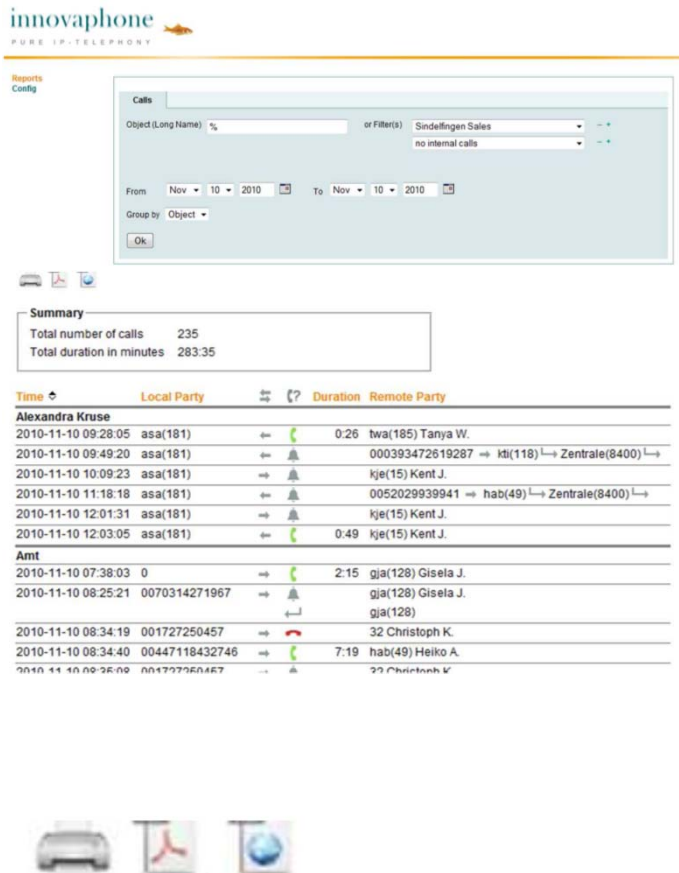

The screenshot displays the 'Reports Config' window for 'Calls'. It includes a search filter for 'Sindelfingen Sales' and 'no internal calls', a date range from Nov 10 2010 to Nov 10 2010, and a 'Group by Object' dropdown. Below the config window is a 'Summary' box showing 235 total calls and 283:35 total duration. The main table lists call records with columns for Time, Local Party, Duration, and Remote Party.

Time	Local Party	Duration	Remote Party
Alexandra Kruse			
2010-11-10 09:28:05	asa(181)	0:26	tw(185) Tanya W.
2010-11-10 09:49:20	asa(181)		000393472619287 → kti(118) → Zentrale(8400) →
2010-11-10 10:09:23	asa(181)		kje(15) Kent J.
2010-11-10 11:18:18	asa(181)		0052029939941 → hab(49) → Zentrale(8400) →
2010-11-10 12:01:31	asa(181)		kje(15) Kent J.
2010-11-10 12:03:05	asa(181)	0:49	kje(15) Kent J.
Amt			
2010-11-10 07:38:03	0	2:15	gia(128) Gisela J.
2010-11-10 08:25:21	0070314271967		gia(128) Gisela J. gia(128)
2010-11-10 08:34:19	001727250457		32 Christoph K.
2010-11-10 08:34:40	00447118432746	7:19	hab(49) Heiko A.
2010-11-10 08:35:02	001727250457		32 Christoph K.

Print, Export come PDF oppure file XML

- Semplice valutazione e panoramica di tutte le telefonate
- Interrogazione di chiamata per singoli utenti o gruppi
- Filtri individuali per interrogazioni su misura
- In funzionamento con il nuovo HW xx10 non necessita di server
- Salvataggio dei Report possibile in file PDF o XML



Applicativi

Softwarephone

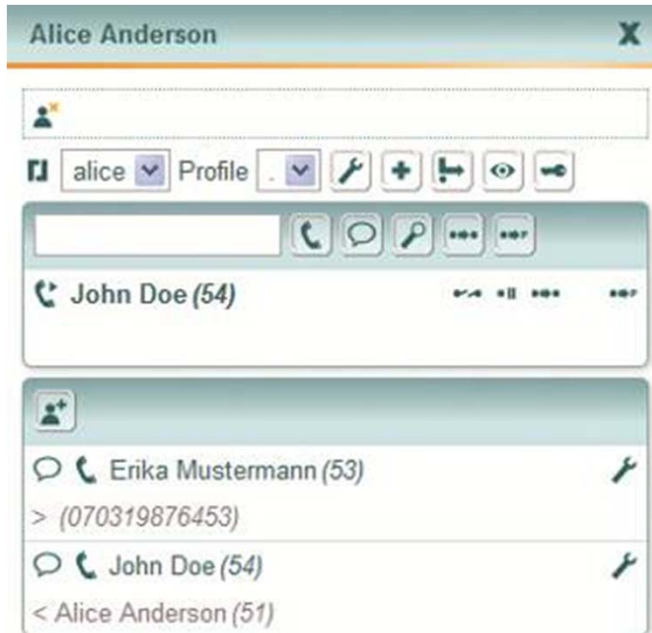

- Nuovo softwarephone innovaphone aggiornato
- Lavora direttamente sul PC dell'utente, senza server
- Integrato in my.pbx e quindi stesso GUI
- Lista preferiti individuale e profilo per gestione contatti flessibile
- Facile gestione delle deviazioni di chiamata
- Ricerca contatti alfanumerica

innovaphone



Applicativi

my.PBX CTI

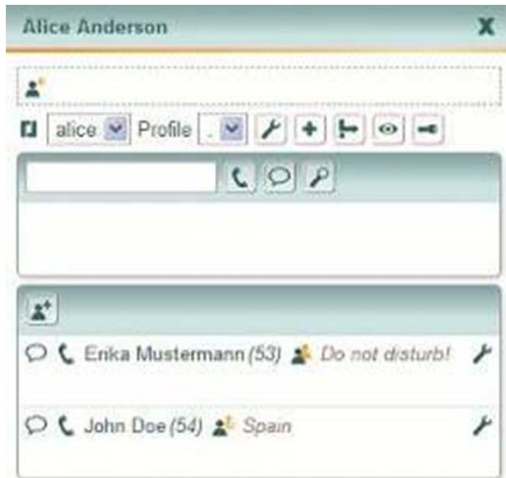

**UC Client
basato su
Web**

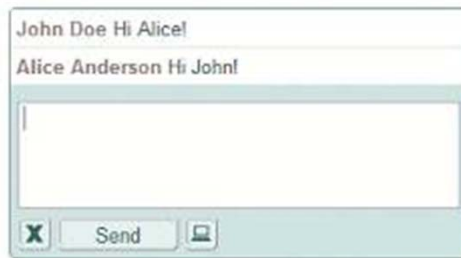

- Introduzione semplice di una soluzione CTI
- Lista favoriti individuale e profilo per gestione contatti flessibile
- Facile gestione del Presence Status per una maggiore efficienza in azienda
- Impostazioni di Privacy Protection garantiscono la protezione della sfera privata
- Facile impostazione delle deviazioni di chiamata
- Ricerca alfanumerica dei contatti
- Funzioni Chat e Multichat
- innovaphone Click to dial Integration
- Finestra di Pop-up con my.PBX
- Con il PXB versione 9 la licenza è gratuita

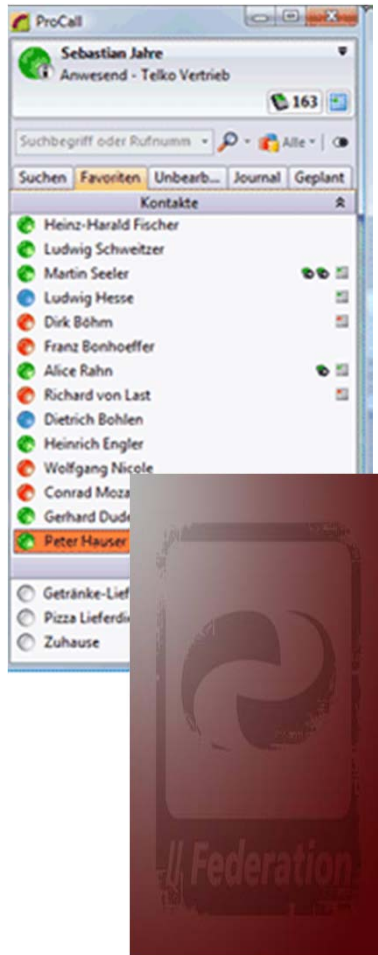

- Estos dispone di una integrazione Presence ancora più profonda di innovaphone (per esempio stato presenza in relazione al calendario, timer inattività ecc.)
- Estos ha un FAT Client (Windows) con stretta integrazione Outlook/Lotus
- Estos Pro Call è il Presence Server per l'innovaphone PBX -> Federazione oltre il confine della propria azienda e verso diversi costruttori
- Hot Key Support



META Directory 3.0

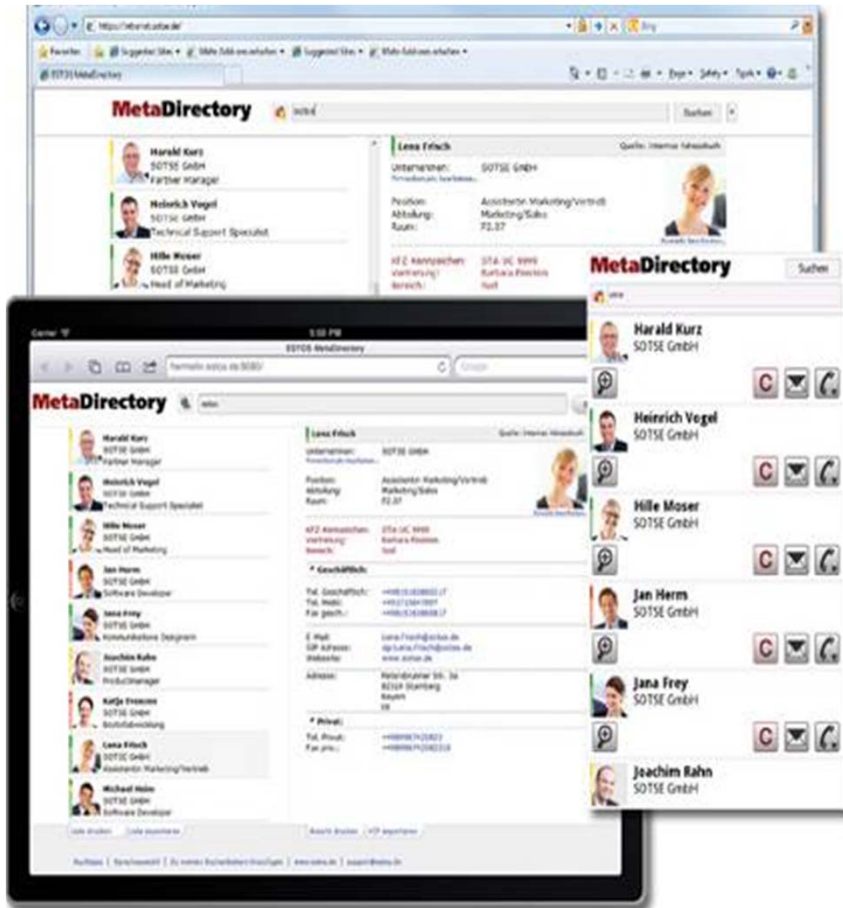

Semplice ricerca di contatti tramite LDAP

Contatti possono essere integrati da:

- Microsoft Dynamics
- sistemi di CRM e ERP
- public Exchange files
- Lotus Notes and Tobit David



Applicativi

Queue Monitor

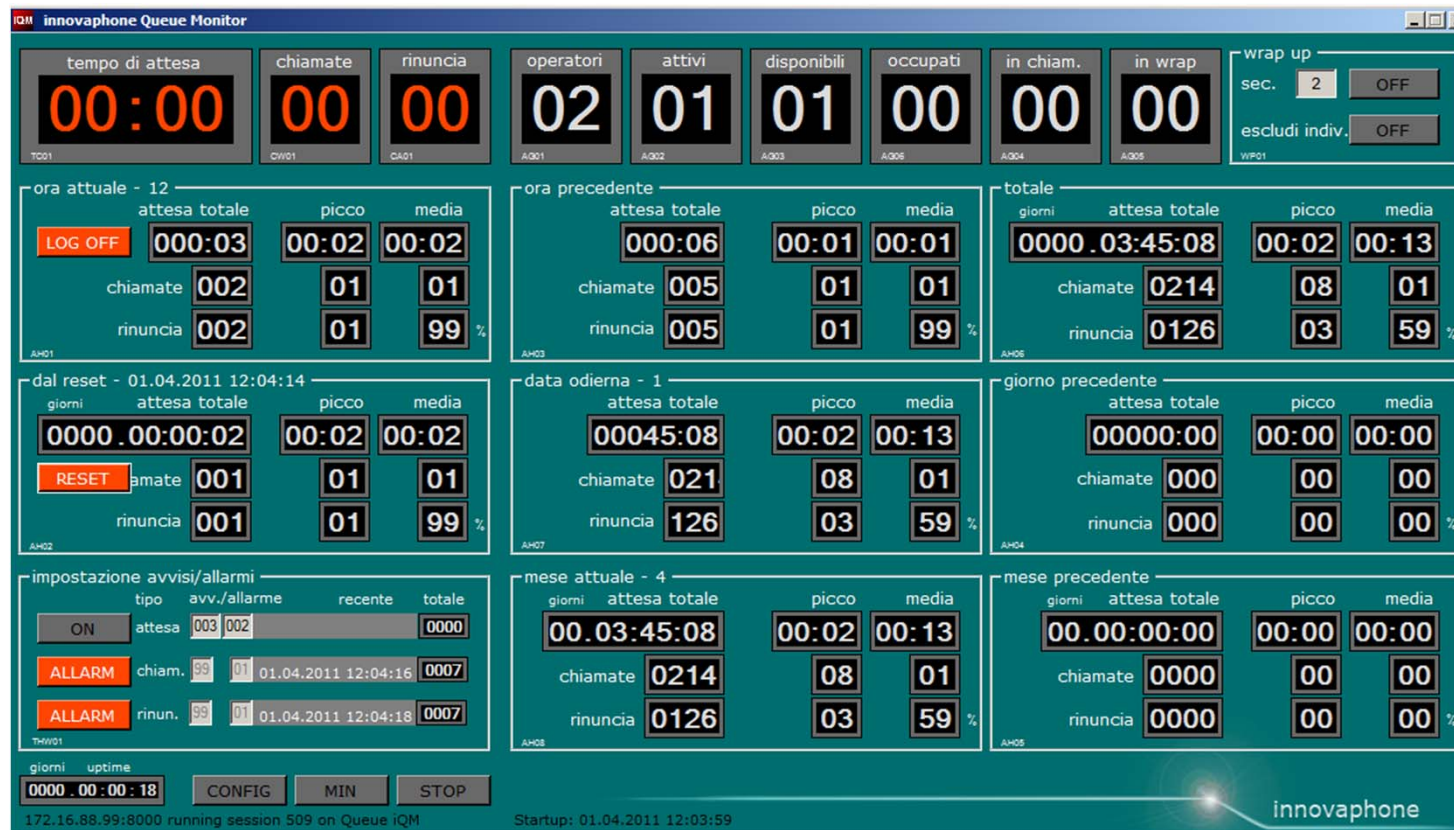

Per capire
cosa succede

- L'innovaphone PBX-Queue Monitor (iQM) permette di supervisionare una Waiting Queue (WQ) e singoli operatori di un innovaphone PBX
- Statistiche in tempo reale aiutano il vostro gestore telefonico a migliorare ed evitare situazioni critiche
- Numerose opzioni di allarme garantiscono che nessuna telefonata sia trascurata
- Il PBX-Queue Monitor opera direttamente su un PC con Windows OC, quindi non richiede server

innovaphone



Applicativi

Voicemail

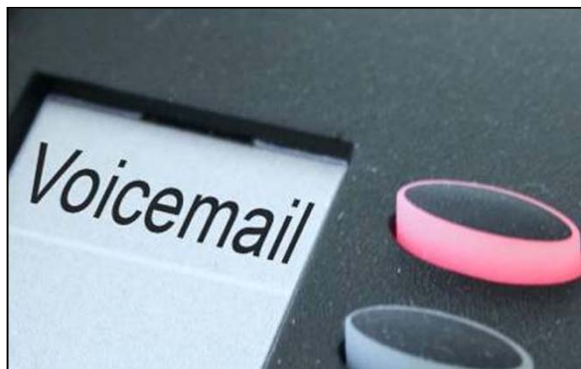

- Non necessita di server, i dati vengono registrati direttamente sulla Compact Flash del gateway
- È possibile inviare una notifica ad un email server e allegare il messaggio
- Segnalazione "messaggio in attesa" (MWI)
- Accesso tramite PIN anche da esterno
- Attivazione automatica
- Semplice adattamento degli XML script



Soluzione Voicemail professionale



innovaphone



Applicativi

Operator

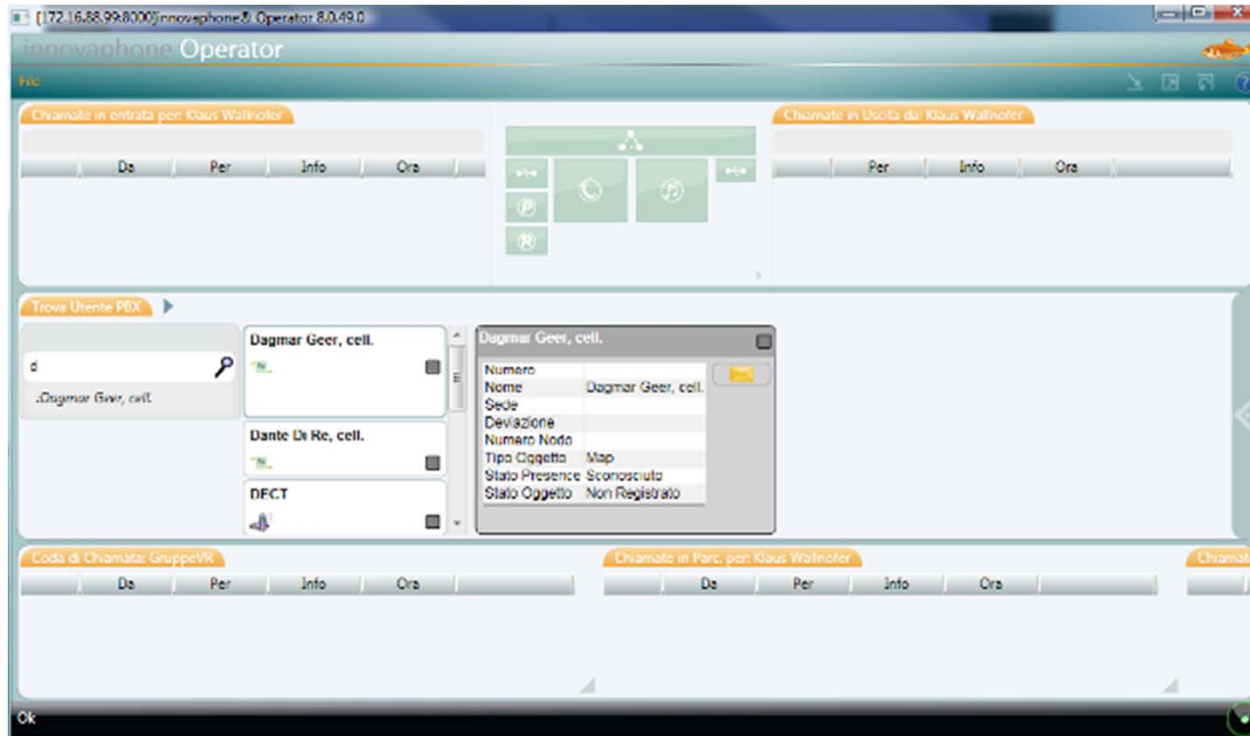

**Il moderno
posto operatore**

- Efficiente posto operatore basato su PC – voce tramite telefono IP
- Tutte le funzioni di un posto operatore di ultima generazione
- Superficie Drag & Drop
- Non richiede server, installazione diretta sul PC dell'utente
- Supporto rubrica Multi-PBX (via LDAP)
- Si adatta da ogni struttura aziendale ,facile connessione di diverse sedi

innovaphone



Recommended Product Program



CTI and UMS Applications

JURVISION



servonic



cobra[®]
computer's brainware

buchberger.it
do IT right

Network Management and Assessment Tools



viola[™]
networks

buchberger.it
do IT right

IP Voice Conferencing System

TE-SYSTEMS
competence in e-communications.

Voice Recording



Messaging / Arlams server

ascom

GSM Gateways

QuesCom

Headsets

GN Netcom

Solutions for mobile Extensions

Teleserver
Mobile Pro

Music on Hold Solution



Call Center Applications

VOXTRON colima
communications

Professional Announcement

HiProCall
High Professional Callmanagement AG

Billing System / Callmanagement

mida
solutions

TELSEN

innovaphone



authensis
AG für Kommunikation



innovaphone fa anche? SI

Sicurezza



Green IT



Telefonia



Standard per integrazione terze parti



Integrazione mobile



Unified Communications



Conferencing / Collaboration



Voicemail /
Messaging



Presence

innovaphone



Soluzioni

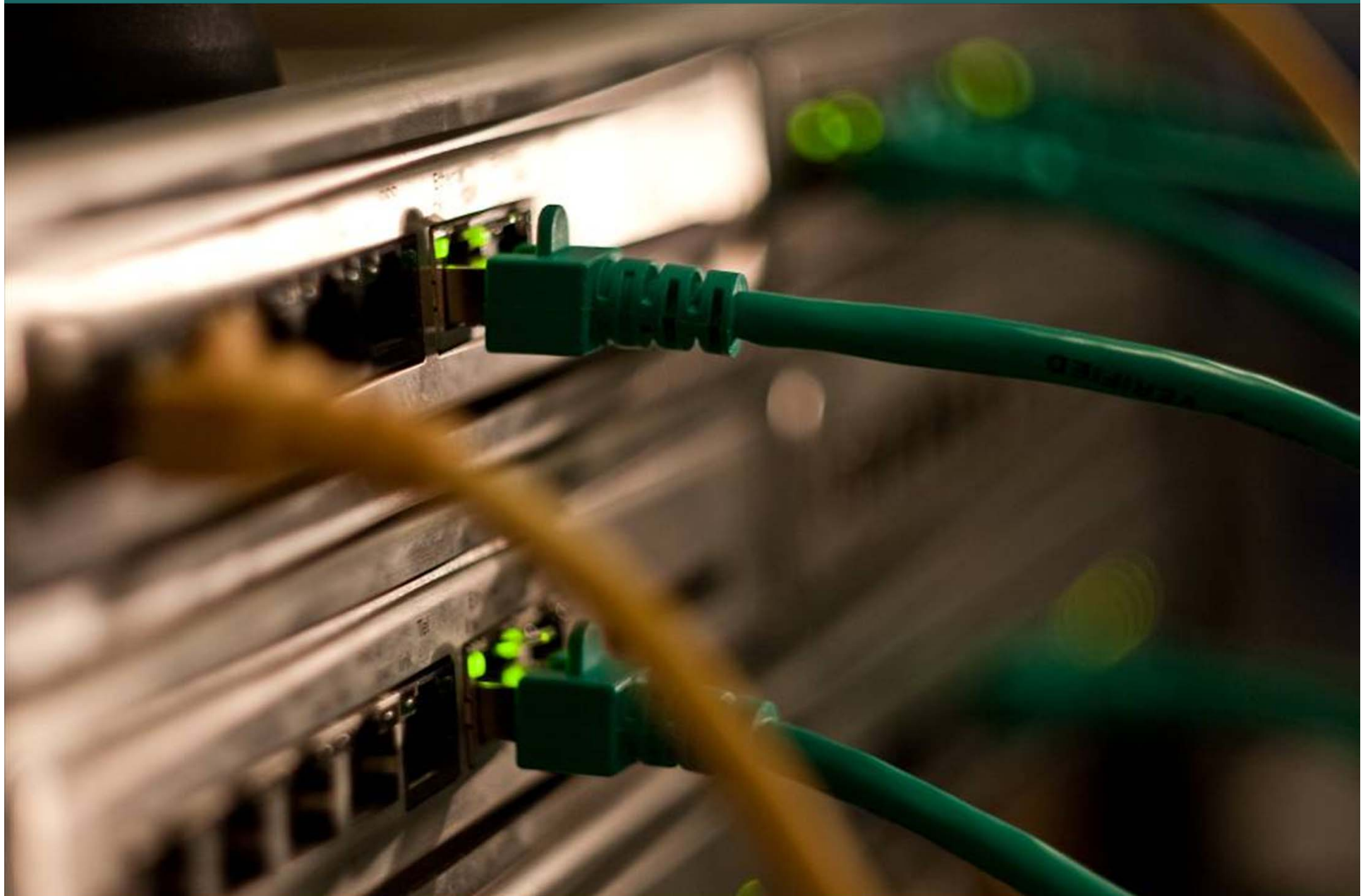

Soluzioni

Trunking

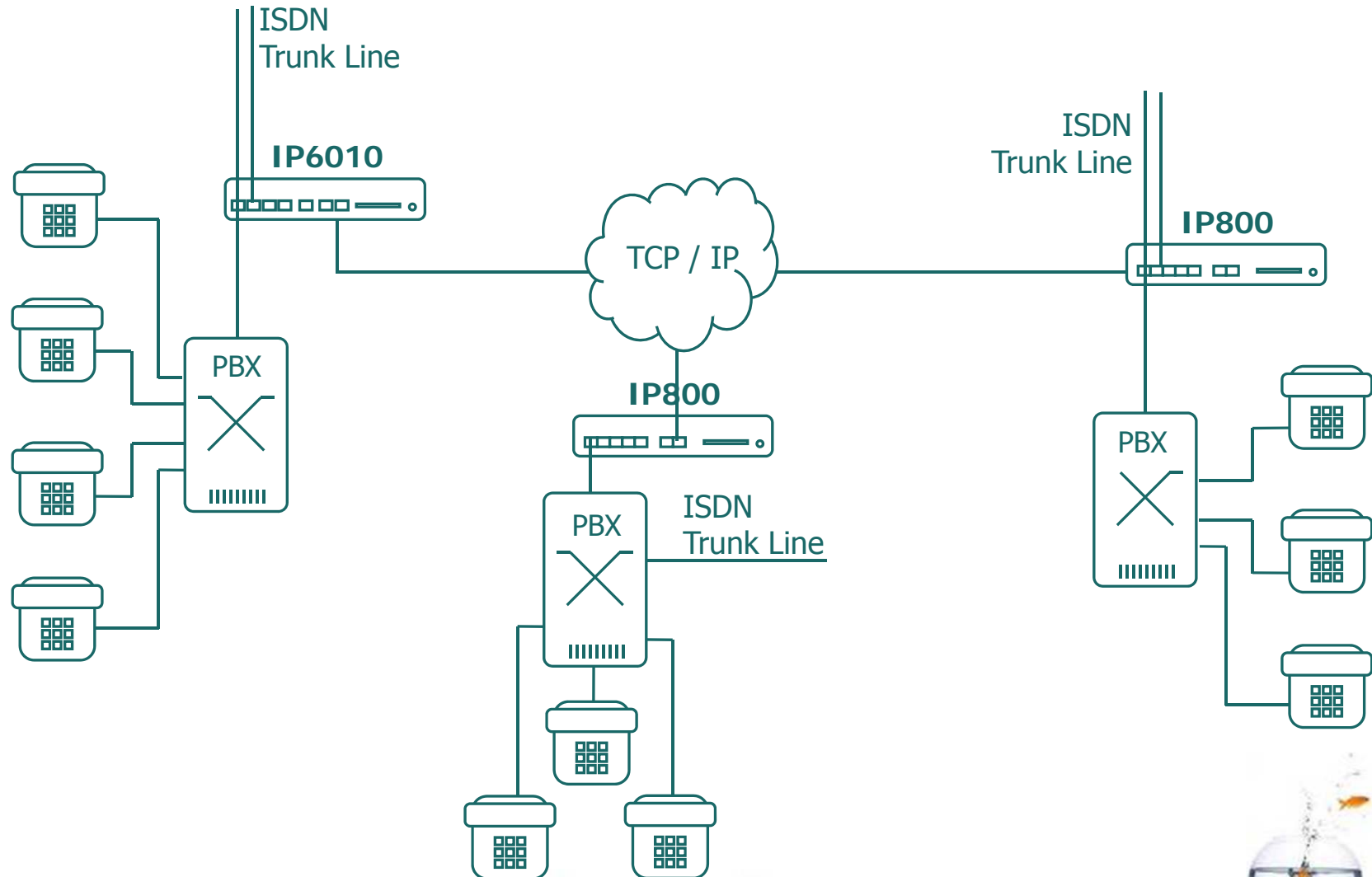

innovaphone



Soluzioni

Migrazione graduale

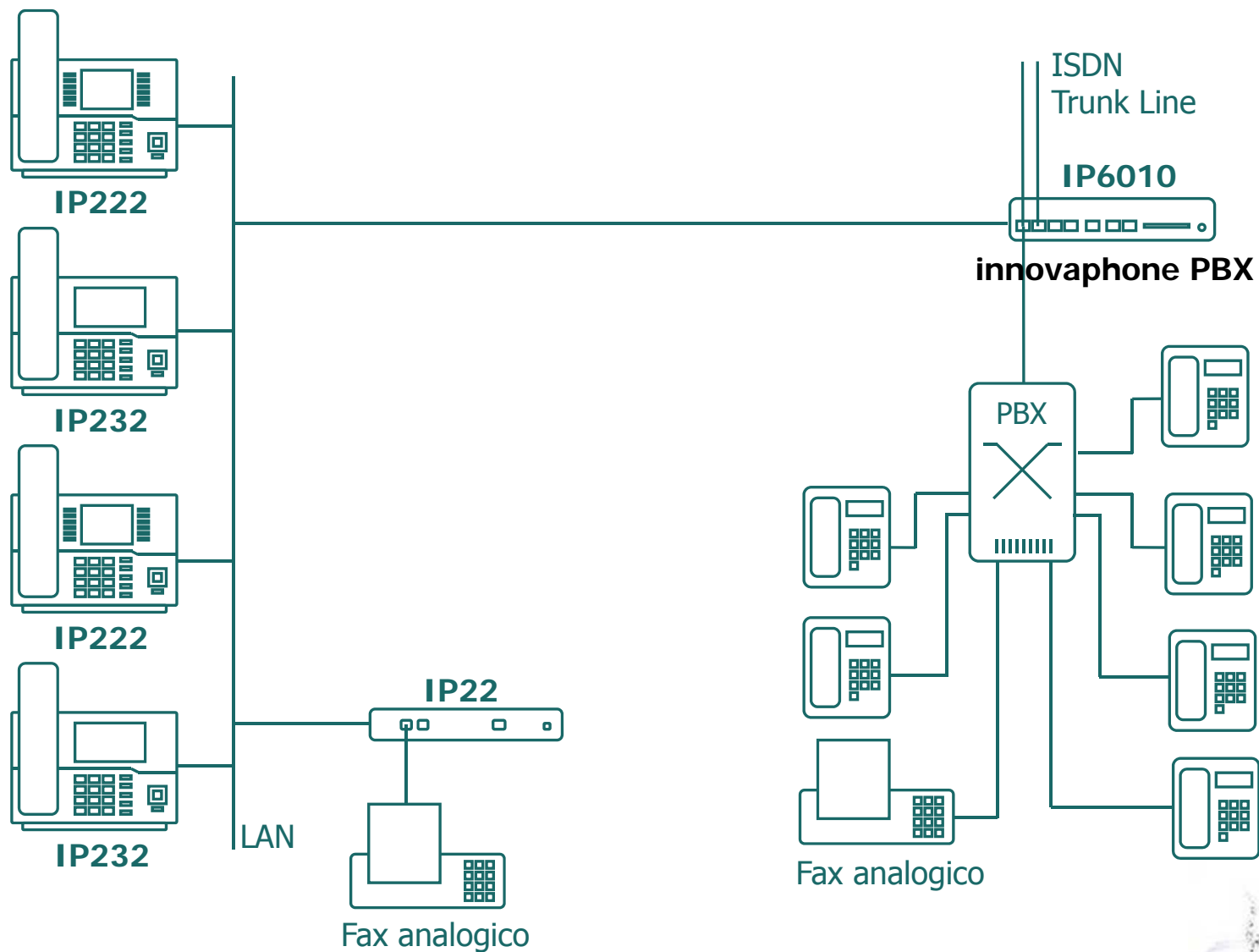

innovaphone



Soluzioni

Multi-Sede

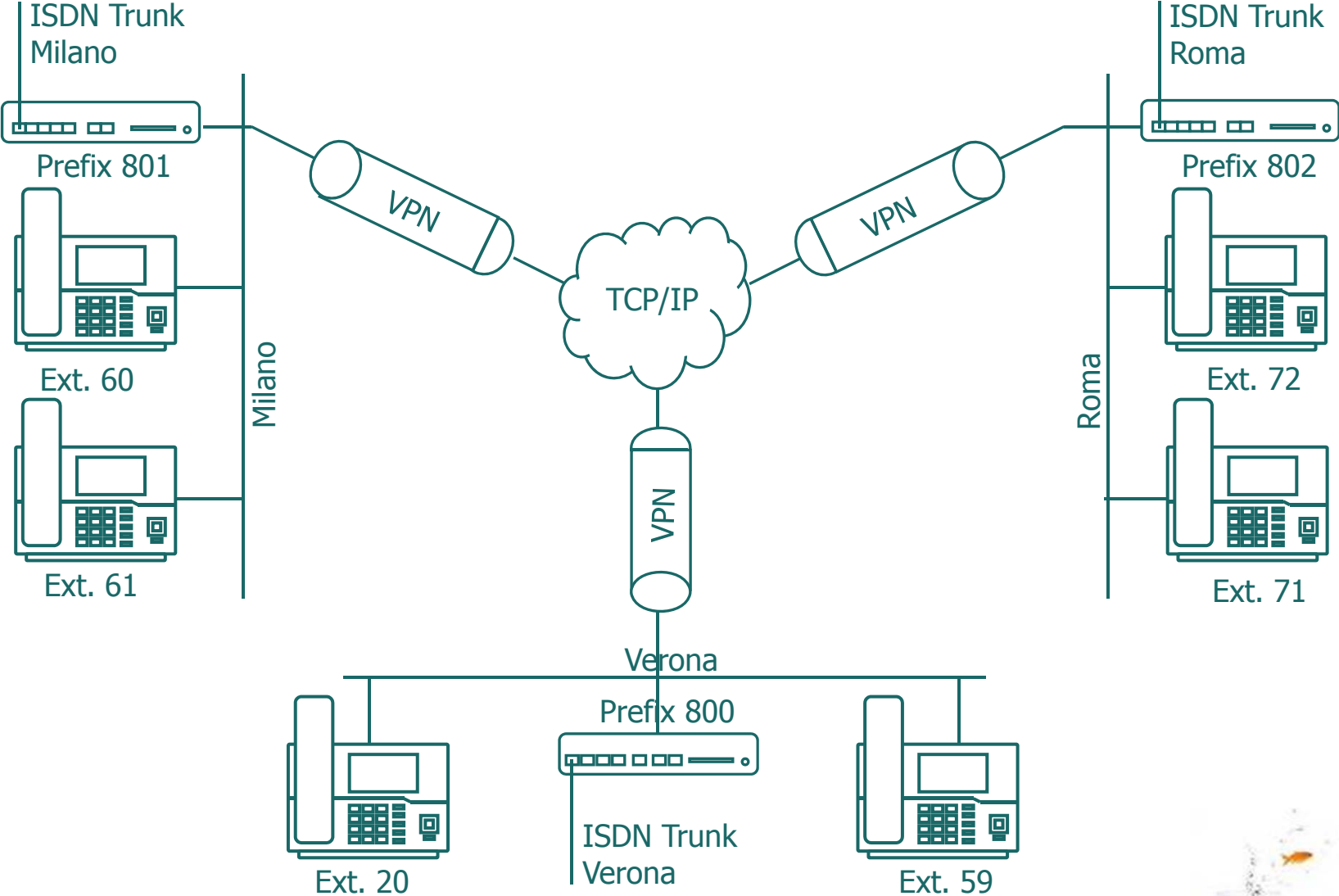

innovaphone



Soluzioni

Sistemi ridondanti

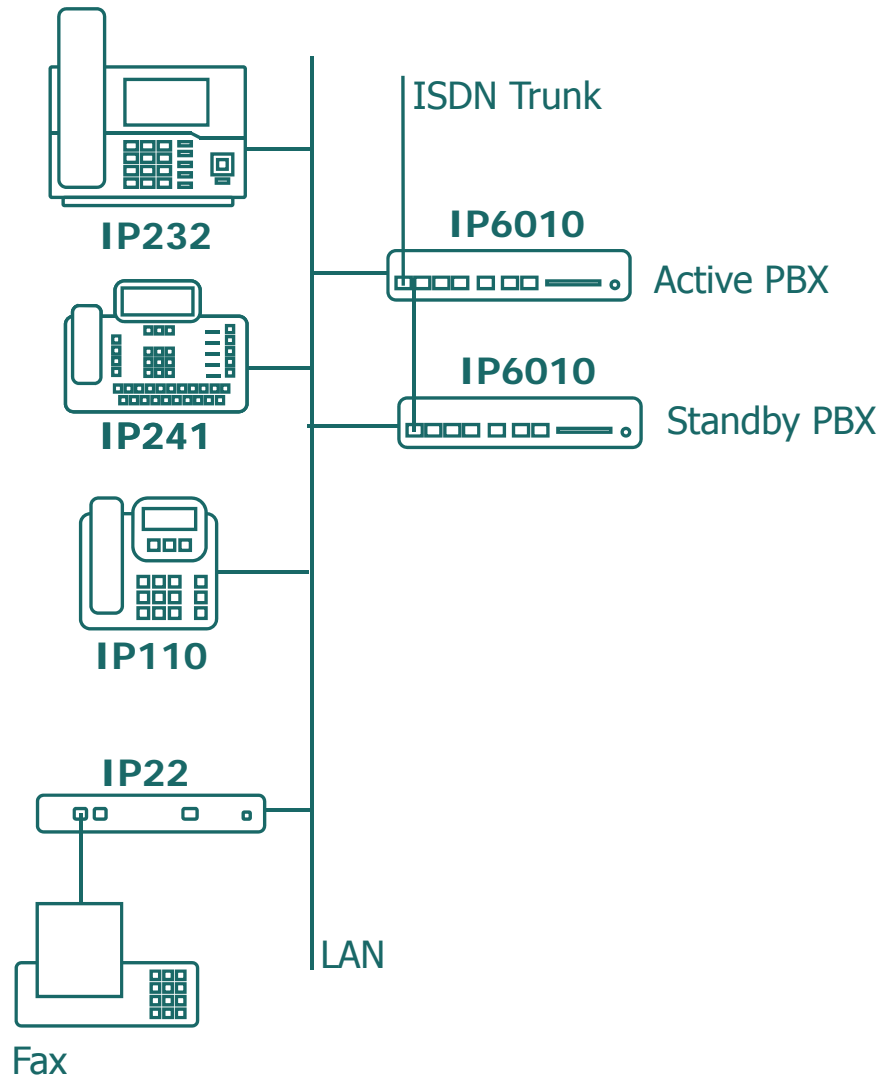

innovaphone



Soluzioni

Sistemi ridondanti

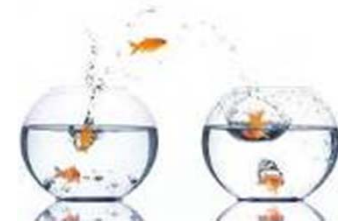
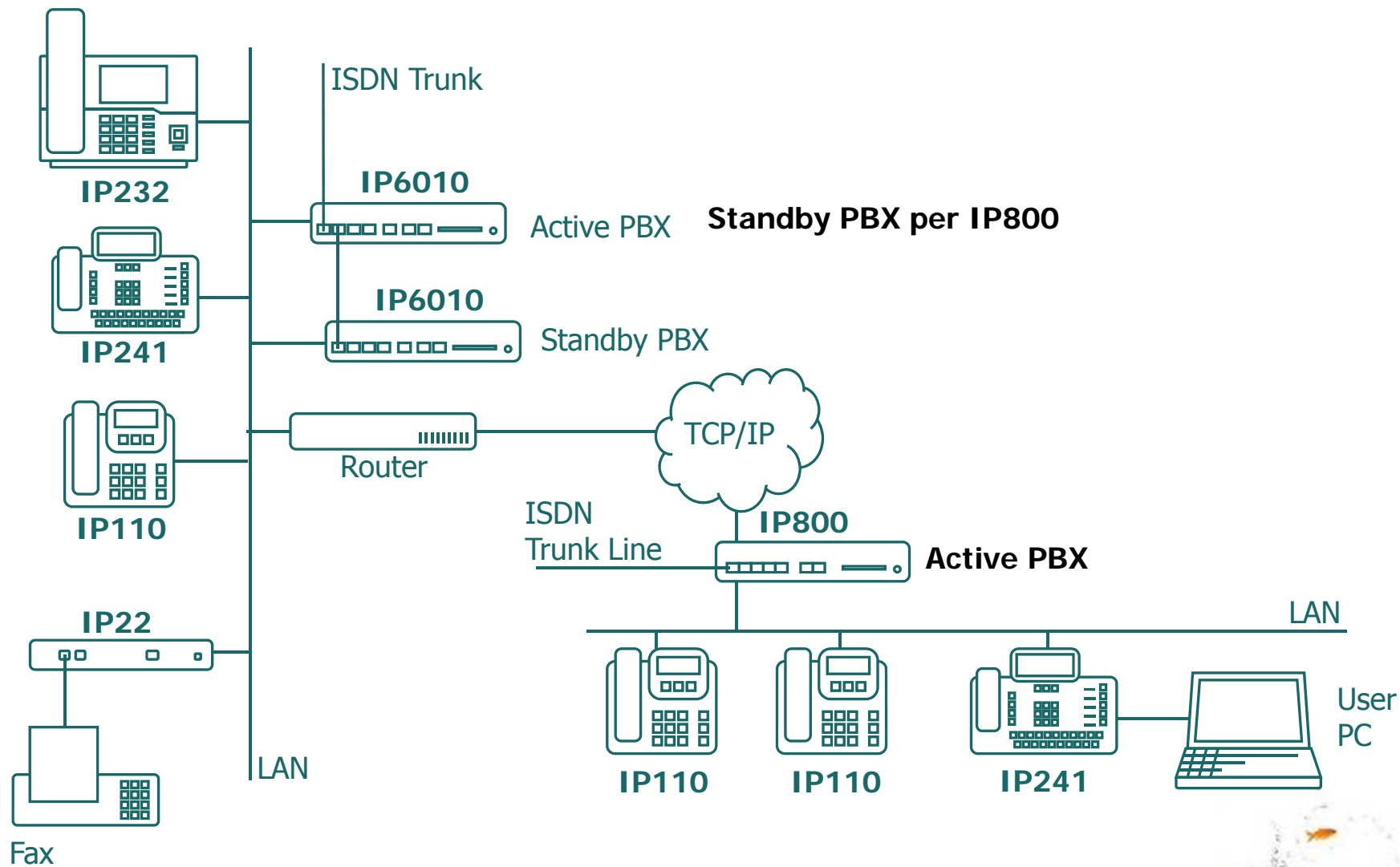

Soluzioni

Compact PBX/piccola filiale

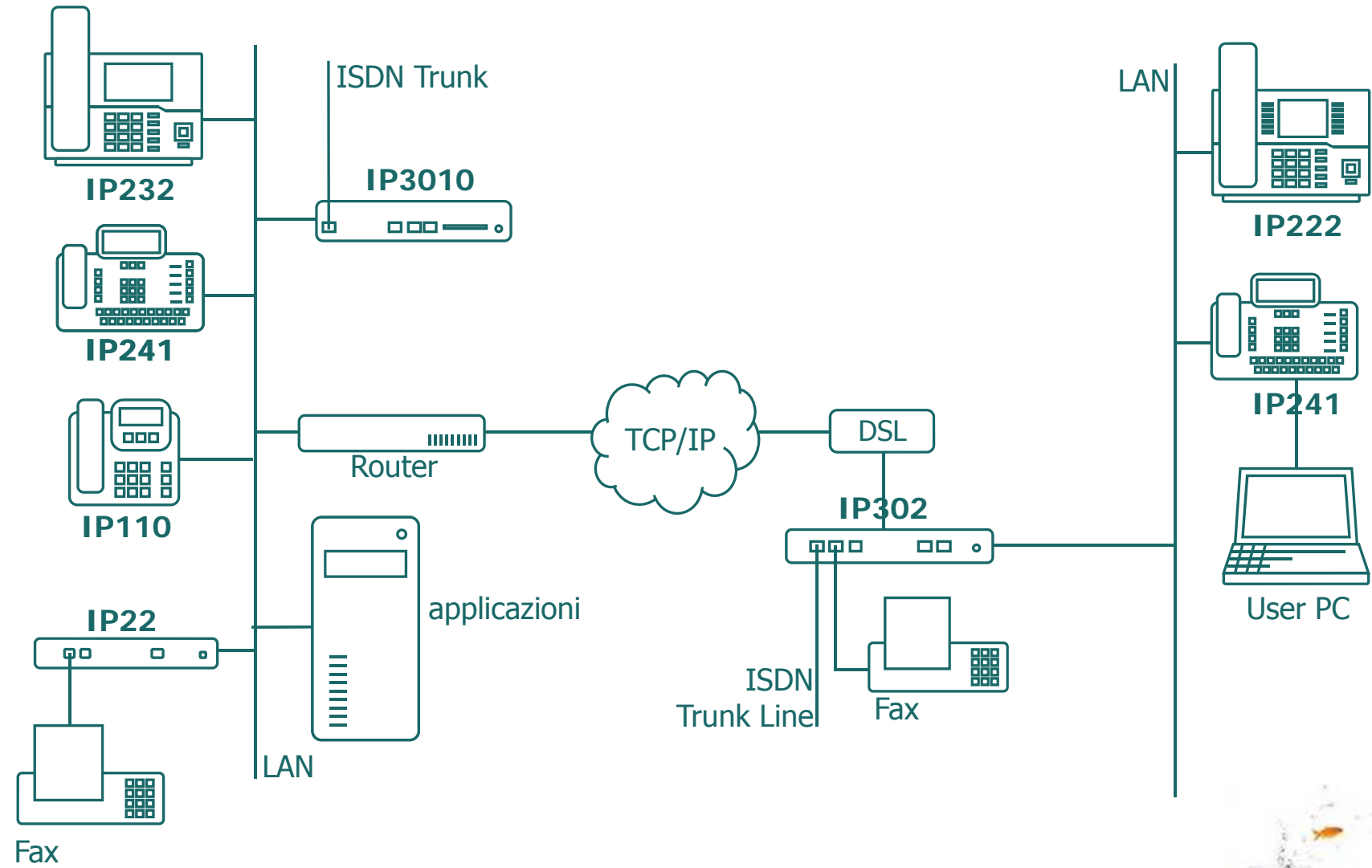

innovaphone



Soluzioni

Telelavoro

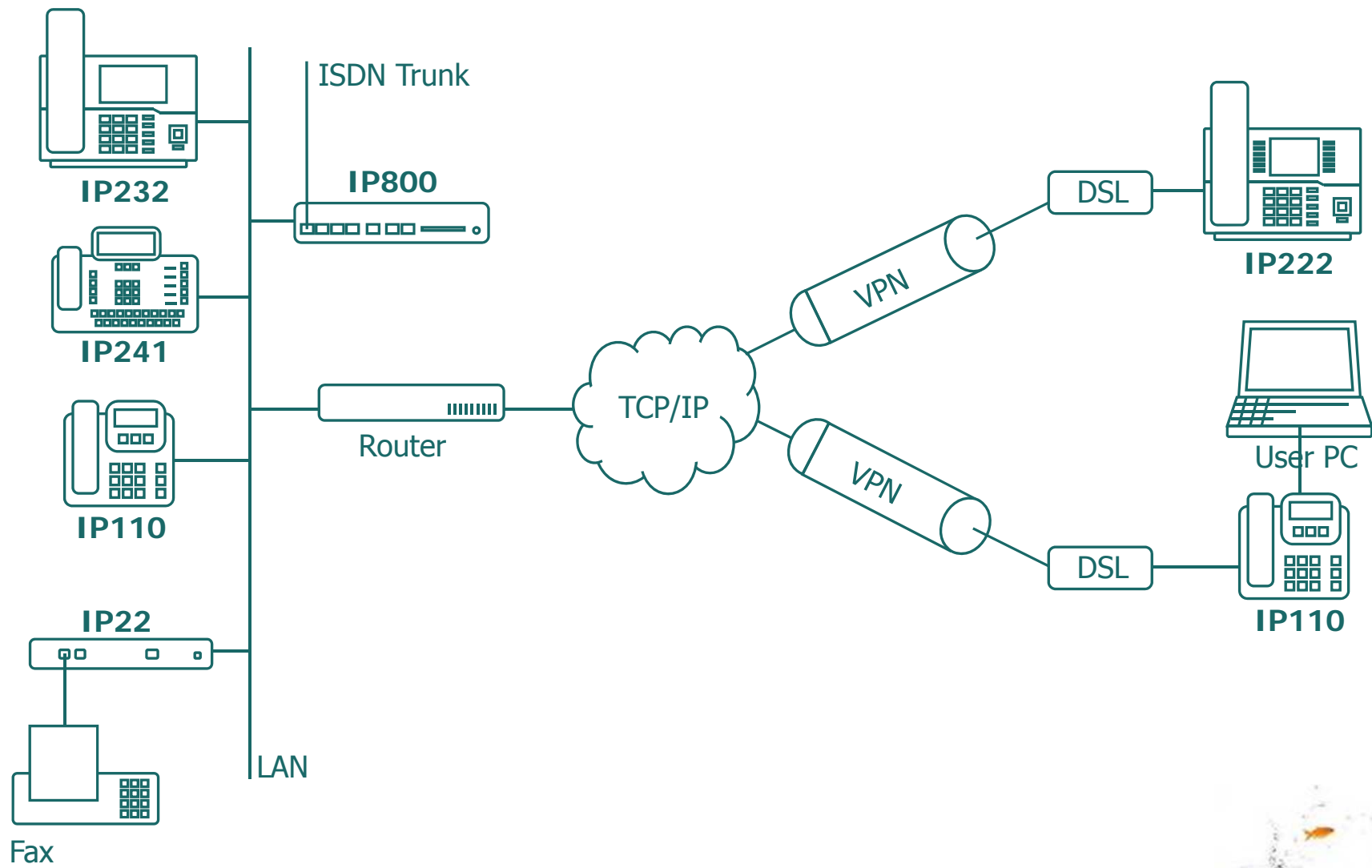

innovaphone



Provider/Hoster

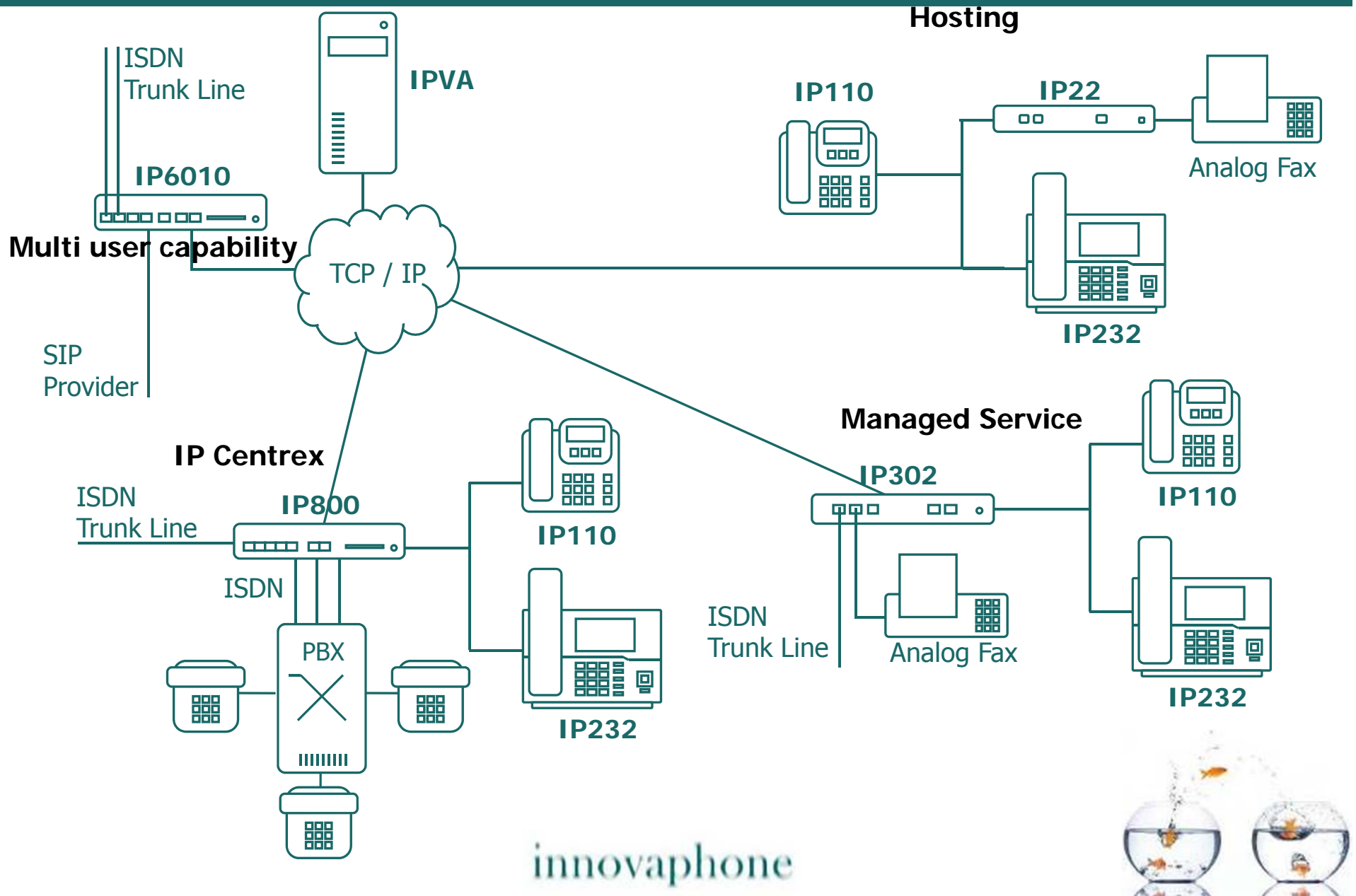

THE ASCOM IP-DECT SOLUTION

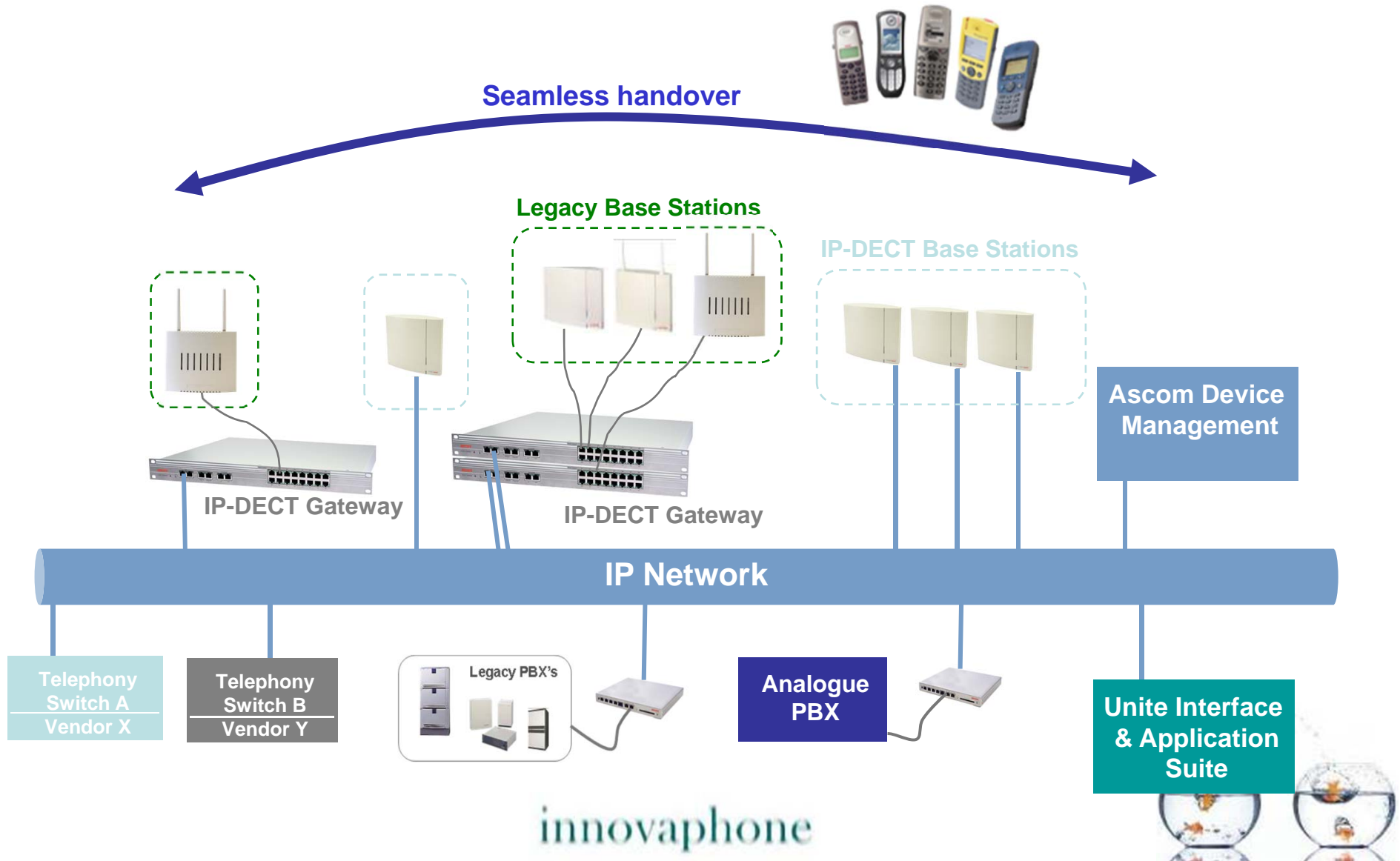

ASCOM IP-DECT PORTFOLIO

End user devices

- Complete range of handsets, chargers & accessories

Infrastructure

- IP-DECT Base Stations
- IP-DECT Gateways incl. TDM DECT Base Stations (BS330, BS340 or BS340-EX)

- Telephony Interface

- Ascom VoIP Gateways (analogue, digital or VoIP)

Messaging

- Unite portfolio



innovaphone

Referenze

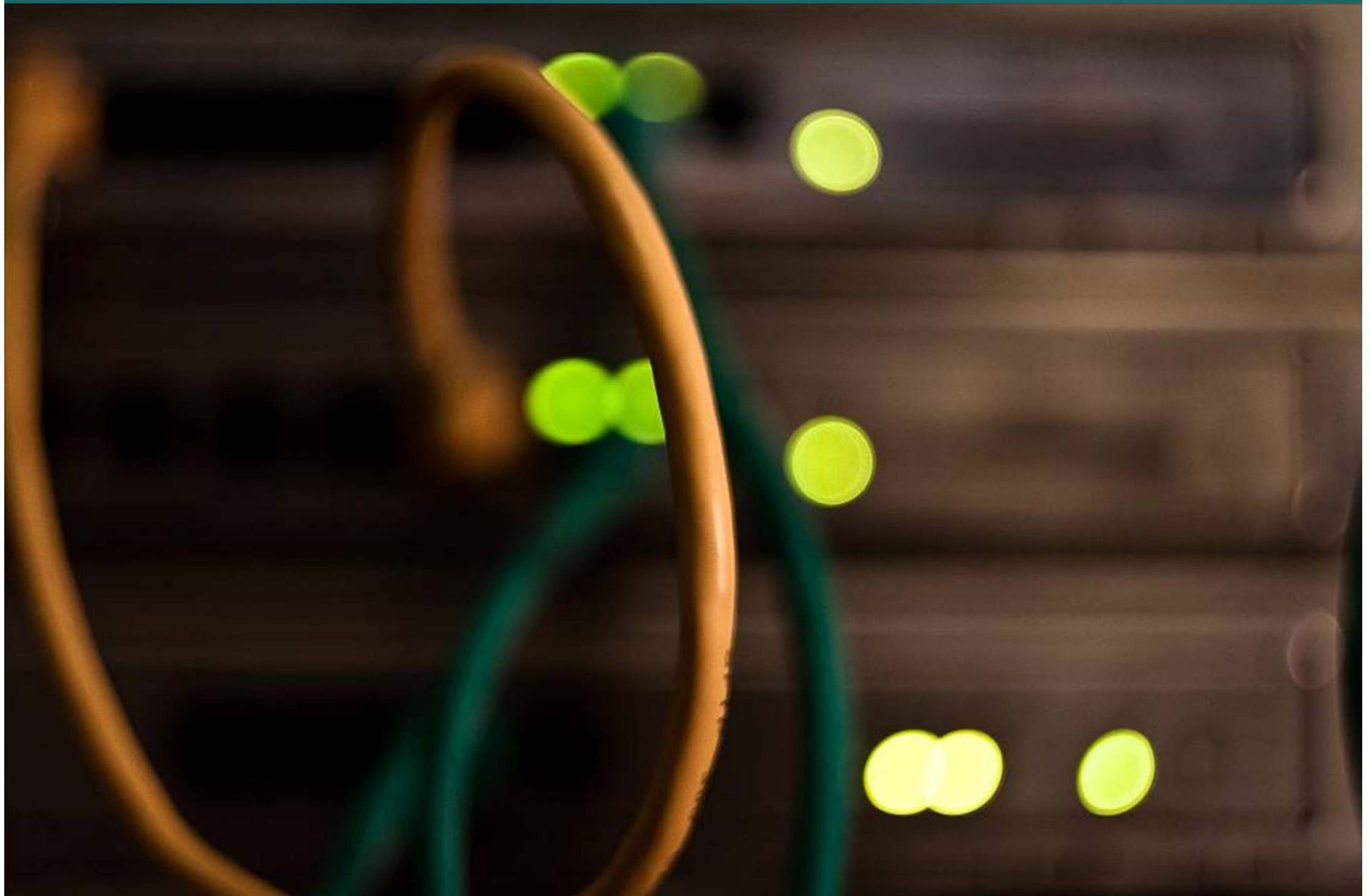

alcuni esempi di integrazione in Italia

Pacorini

Osp. Bressanone

Rubner

Italease

Zoppas

Fondital

Osp. Massa

Azimut

Banca Intesa

Glaxo

Siemens Hicom300

Siemens Hiptah

Alcatel

Ericsson MD110

Ericsson MD110

Ericsson BP250

Philips

Cisco CM

Cisco CM

Cisco CM



innovaphone



alcuni clienti in Italia....

Fincantieri

Sacbo

Mastrotto

Cordivari

Sagam

MB Roma

Bcc Lombardia

Tigros

Despar Sicilia

AEMcom

Perazzi

Esercito

Telespazio

Cantieri navali

Aeroporto Orio al Sirio

Conceria

Industria sistemi termici/solari

Filiali Volkswagen

Filiale Mercedes

Finanziaria

Supermercati

Supermercati

Carrier

Industria (Armi)

Italiano

Carrier

innovaphone



alcuni clienti della PA in Italia....

Concorezzo	Comune
Novate	Comune
Abbiategrosso	Comune
Carugate	Comune
Ponte Dera	Comune
Udine	Provincia
Trieste	Comune
Rho	Comune
Lucca	ASL
Pontremoli	Ospedale
Aulla	USL
CNR	Roma e Antartide

innovaphone



...alcuni clienti in Europa....

DFN	Rete di ricerca nazionale - Germania
Scania	Veicoli industriali - Estonia
Letz Sushi	Fast Food - Danimarca
Meinl Bank	Finanziaria - Austria
Finkenberg	Commercio – Finlandia
Fritec	Industria – Francia
Rana	Alimentari – Francia
PolFarskt	Industria alimentare – Svezia
Douglas	Distribuzione – Europa
Spar	Alimentare – Svizzera
Gegenbauer	Servizi – Germania
BKA	Polizia – Germania
Expert	Distribuzione – Svezia

innovaphone



BKA e Axel Springer



www.bundeskriminalamt.de



BKA

Progetto complessivo 12.000 interni



Progetto complessivo 15.000 interni



I nostri Partner



innovaphone



innovaphone Struttura aziendale

Two Tier sales model B-to-B

innovaphone

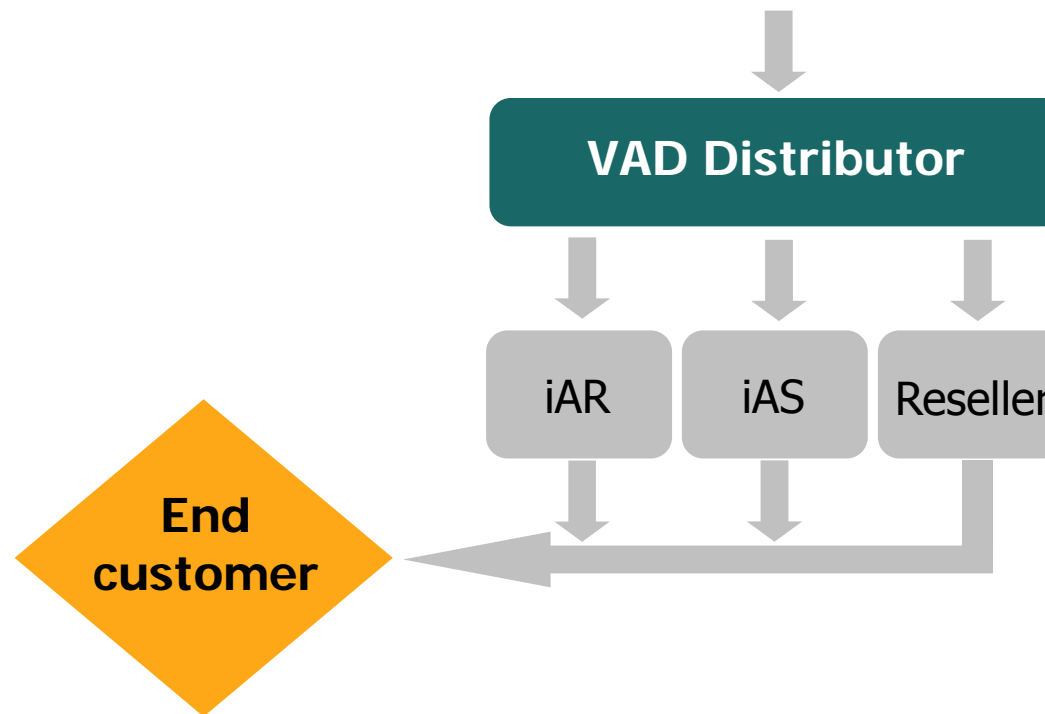

innovaphone



Che cosa significa questa certificazione per tutti coloro che non hanno ancora deciso ?



Sicurezza

Per tutti gli interessati e nuovi clienti:
Ora: Libertà di scelta per l'uso di UCC
In futuro: Integrazione on demand

Libertà

La scelta di una soluzione **innovaphone**
Vi da completa libertà nella scelta degli
applicativi oggi e in futuro



Vantaggi per il venditore



- Vendete un prodotto garantito che non vi riserverà spiacevoli sorprese dopo l'installazione
- Non è il più economico ma il più vantaggioso qualitativamente
- Il suo rapporto qualità/prezzo è insuperabile
- Supera nel confronto tecnico qualsiasi altro prodotto
- E' perfettamente inseribile in ogni scenario
- Il preventivo è facilmente calcolabile

Presentatelo al cliente con queste certezze e senza timori

innovaphone

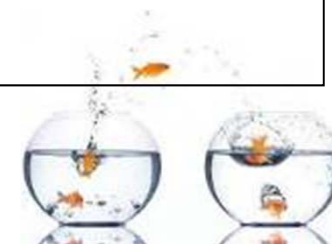

Fatto! Ma.....

**Decisamente troppo per una
presentazione!**

**Appena abbastanza per
entrare nel mondo
innovaphone.**

Domande?





Grazie per l'attenzione!

innovaphone.com